

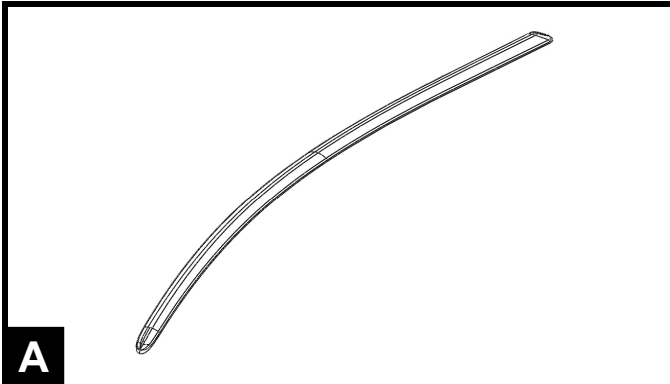

FIAT 500 Hood Spear

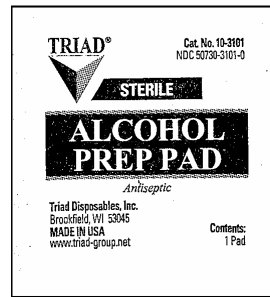

A



B

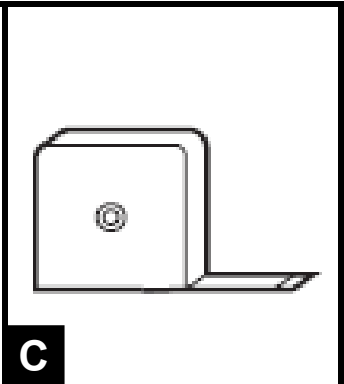

C

Installation Temperature:
16-43°C (60-110°F)



Do not wash vehicle for 24 hours after installation

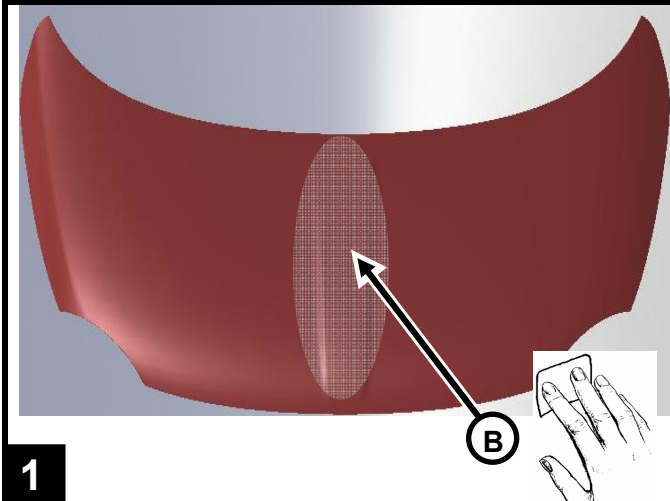

1

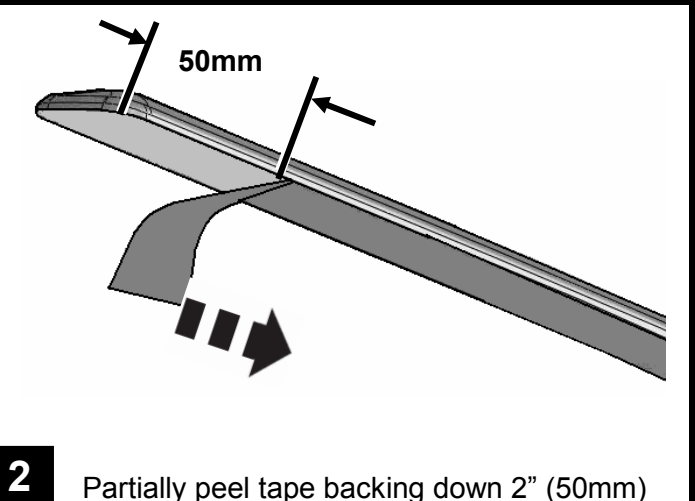

2

Partially peel tape backing down 2" (50mm)

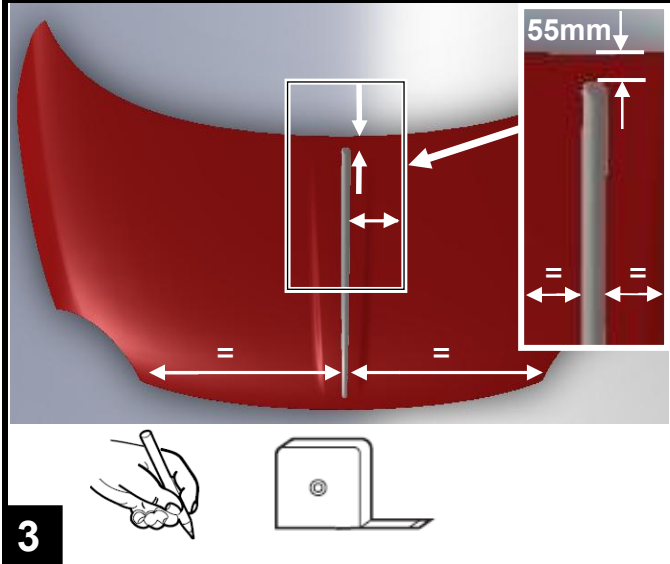

3

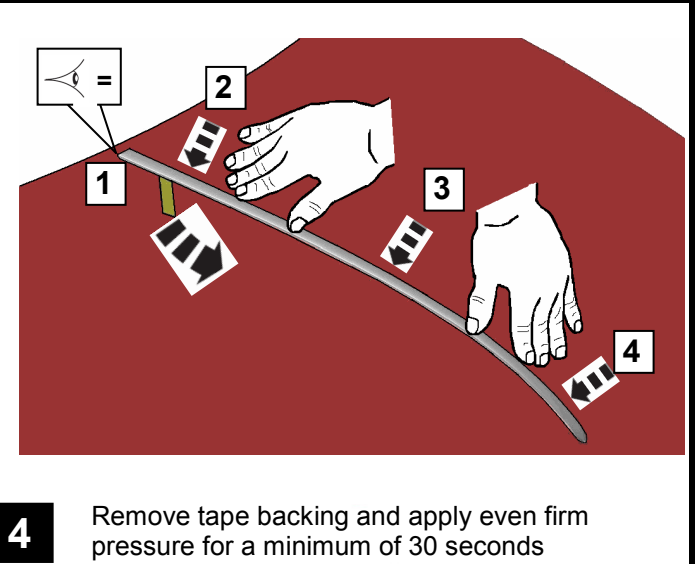

4

Remove tape backing and apply even firm pressure for a minimum of 30 seconds

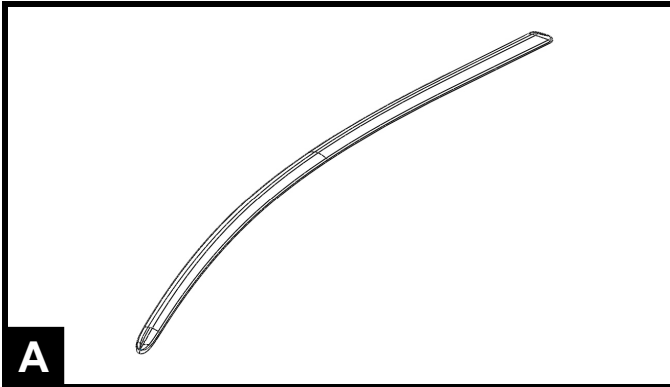

A

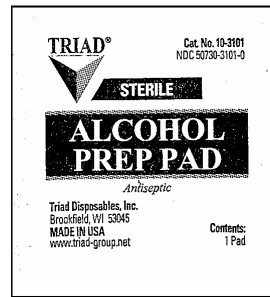

B

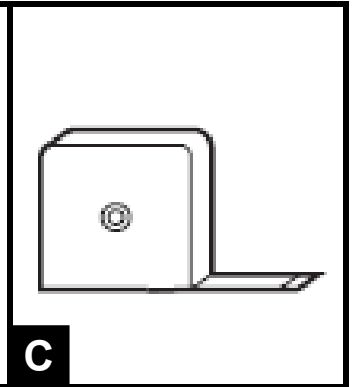

C

Temperatura de Instalación:
16-43°C (60-110°F)



No lave el vehículo por 24 horas
después de la instalación

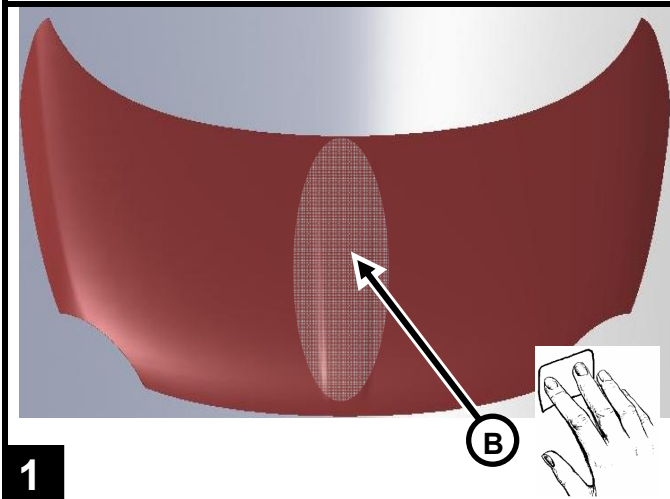

1

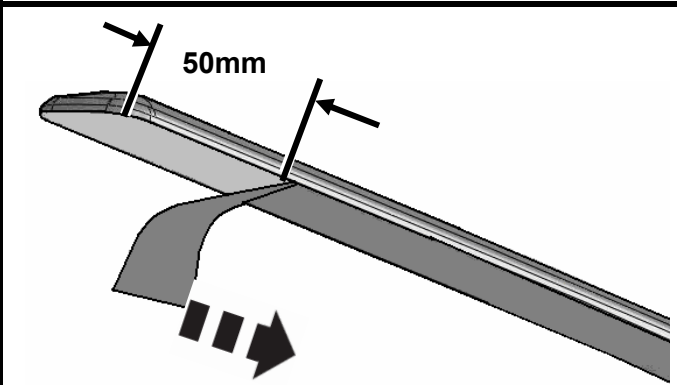

2

Quite el forro de cinta aproximadamente 2" (50mm)

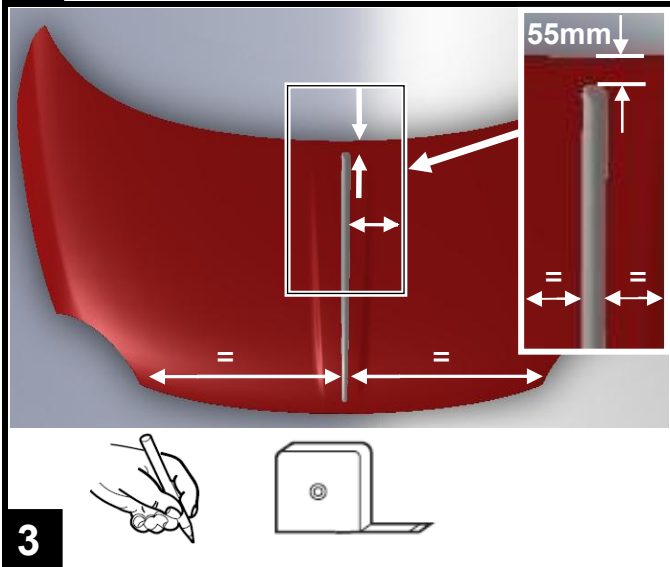

3

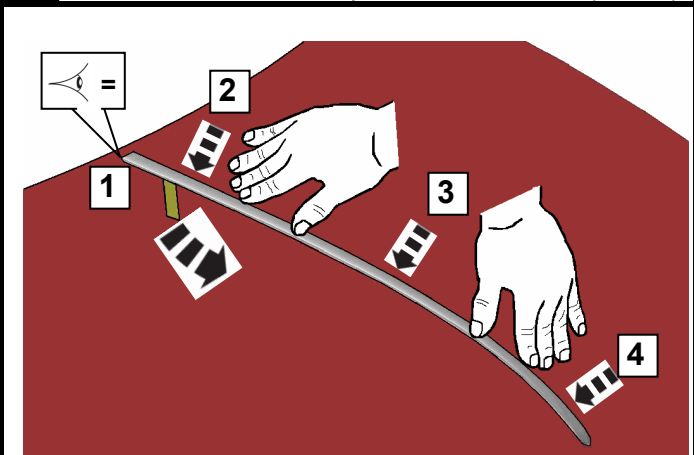

4

Quite el forro de cinta y aplique una presión
firme por un mínimo de 30 segundos

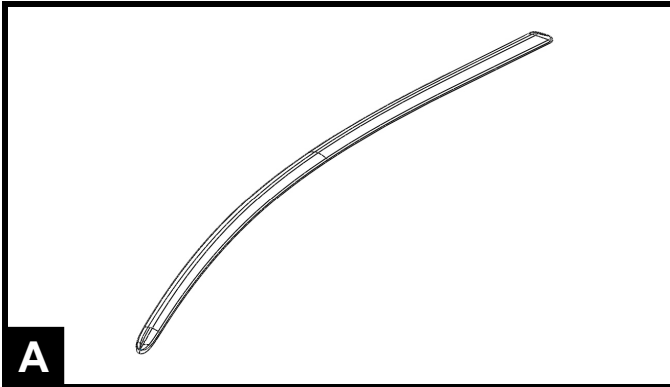

A

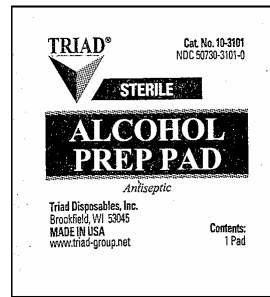

B

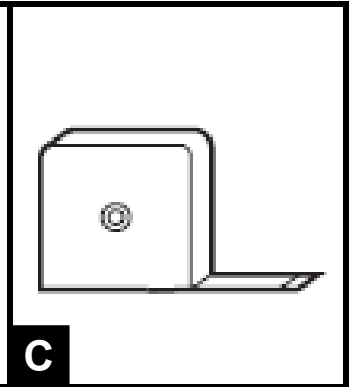

C

Température d'installation:
16-43°C (60-110°F)



Ne pas laver le véhicule pendant 24 heures après l'installation

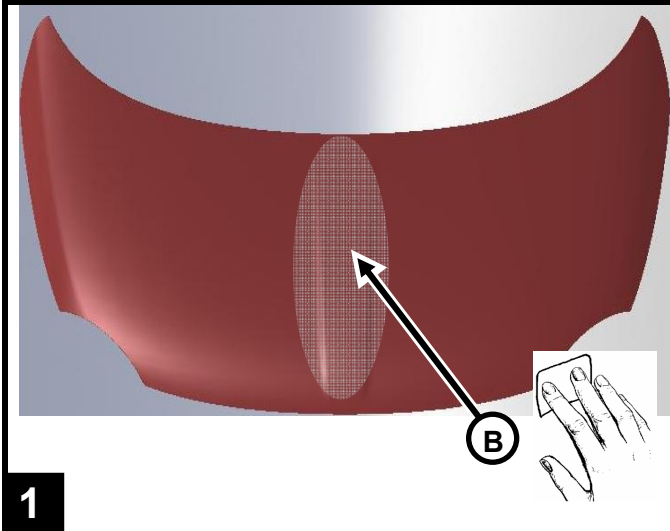

1

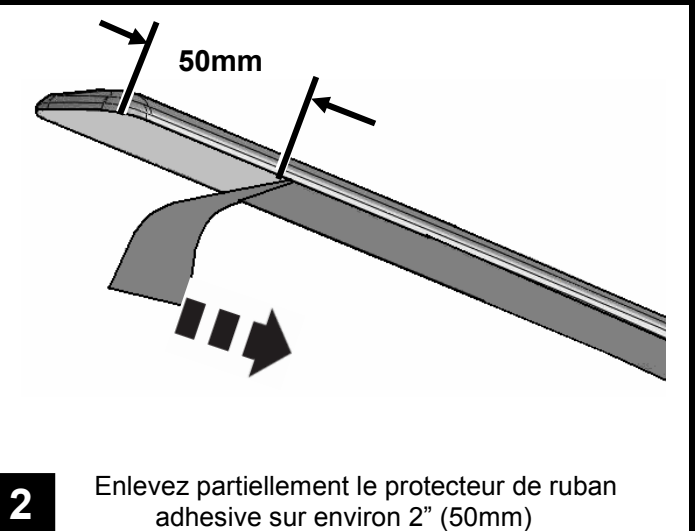

2

Enlevez partiellement le protecteur de ruban adhésive sur environ 2" (50mm)

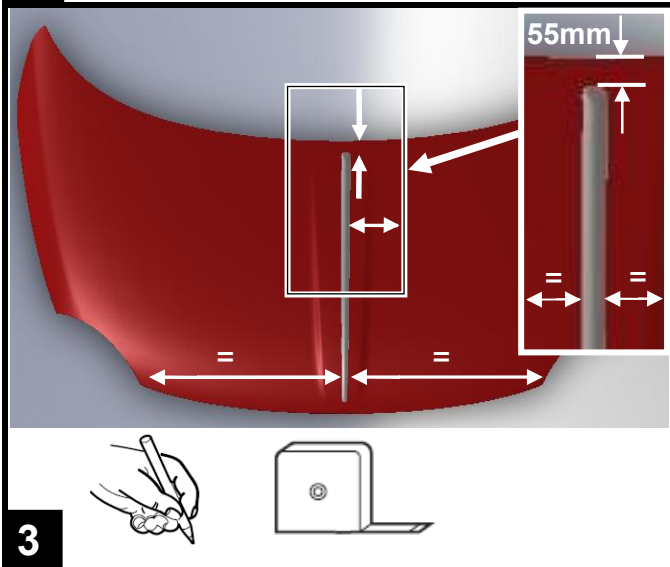

3

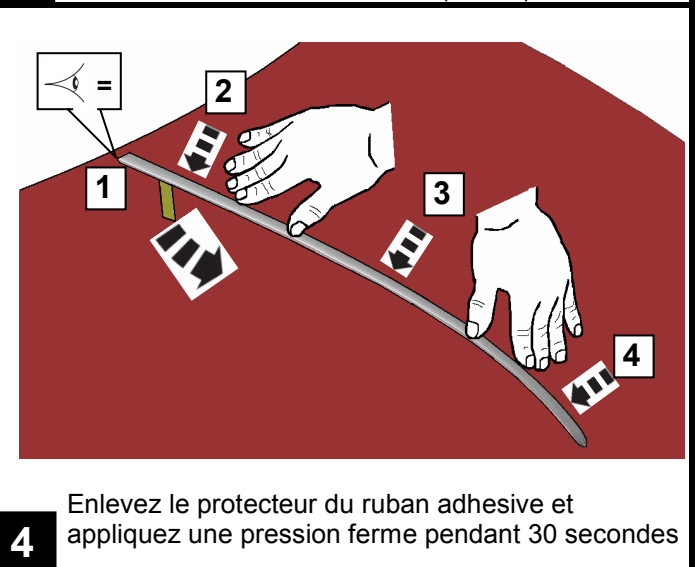

4

Enlevez le protecteur du ruban adhésive et appliquez une pression ferme pendant 30 secondes